

SERIES 1-2: QUEEN & CORNER BRACKETS ASSEMBLY GUIDE

Structural Deck Support System: Product Numbers: H1-GQ, H2-GCL (Also applies to H1-GK and H2-GCR)

STEP 1: Following the spacing guidelines per the deck design and joist layout, mark the location of each H1-GQ Queen 4" Deck Ledger Support Bracket. Mark the level and height with a chalk line for where the top of H1-GQ bracket needs to sit in order to accommodate your deck floor height.



STEP 2: Line the divot in the H1-GQ back plate with the marks made along the chalk line.

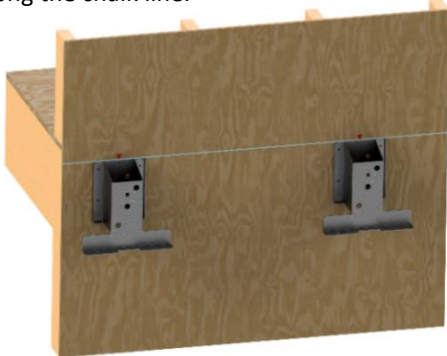

STEP 3: Fasten the H1-GQ bracket into position with 4 screws or nails.

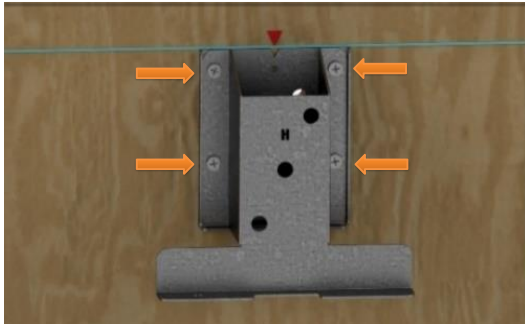

STEP 4: Drill from the front of bracket through the rim board. The bracket acts as a guide for straight, accurate holes. Use 5/8" bolts (2 ea. for residential, 3 ea. for commercial) and 12" long drill bit (recommended: Republic Tool Corp. #212 x 21/32") <https://www.mcmaster.com/#2464a18/=1ea711c>

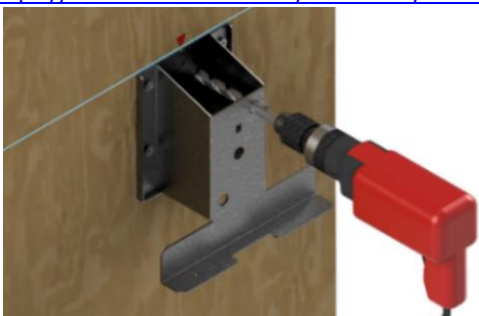

STEP 5: Bolt ledger board to brackets and wall, keeping the head of the bolt and washer inside the house. (Make sure adequate (1.5") space is left on end of ledger board from end of queen lip for appropriate installation of H2 corner series brackets and outer deck joist(s).



STEP 6: Caulk bolt hole within the bracket for protection from the elements.

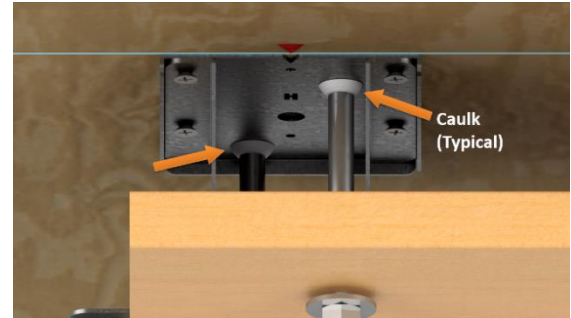

STEP 7: Attach the H2-GCL utilizing the bolts from the H1-GQ bracket.



STEP 8: Fasten vinyl weather barrier to wall and drape 1 inch over flashing.



(Continued on Back)

STEP 9: Leaving a 1" air gap from wall, **brick up between ledger and wall, around brackets.**

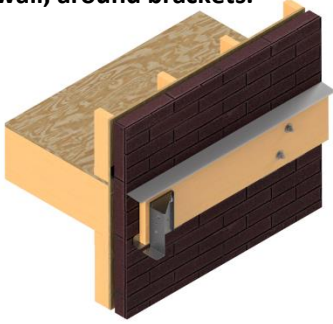

STEP 10: Illustrated side view for masonry detail.

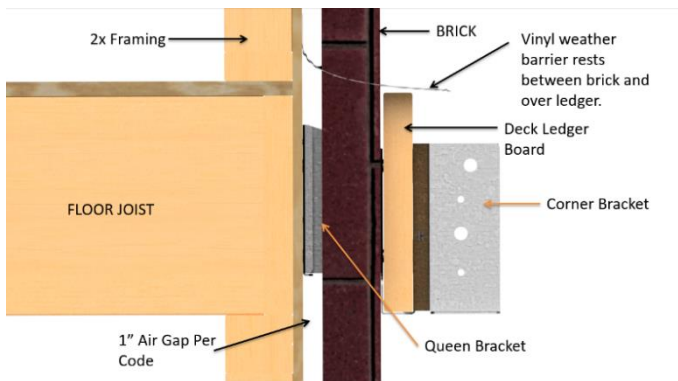

STEP 11: Attach the rim boards by normal fastening methods and temporarily secure the corner bracket with 2 screws or nails as shown.



STEP 12: Fasten 4x4 handrail post with temporary toenailing or clamps. Drill through rim joist and 4x4 post allowing the corner bracket to act as guide.



STEP 13: Bolt the rim joist assembly together with the heads of the bolt and washer to the 4x4 side.



STEP 14: Use 3" width galvanized flashing along the length of the ledger board.



*Vinyl weather barrier not shown for clarity.

STEP 15: Illustrative view below to show how flashing is positioned under vinyl.



STEP 16: Installation Complete!

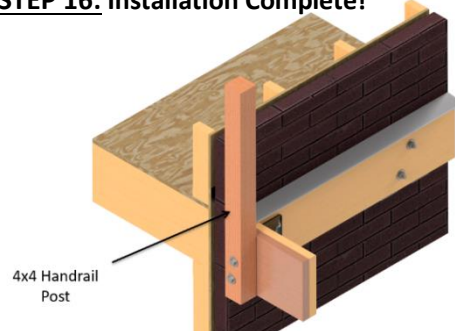

FOR ILLUSTRATED PURPOSES ONLY: SEE ADDITIONAL GUIDELINES PER DECK DESIGN PROFESSIONAL & LOCAL CODE AUTHORITY. INSTALLER IS RESPONSIBLE FOR PREVENTING WATER INTRUSION. TIGHTEN ALL BOLTS & SEAL ALL CAULK. FASTENERS MUST MEET OR EXCEED LOCAL CODE (REC: HDG ASTM 123 HOT DIPPED GALVANIZED OR STAINLESS STEEL) INSTALL ONLY IN PROVIDED, SPECIFIED HOLES. SEE HDGEP.COM FOR SPECS/VIDEOS

HDG ENGINEERED PRODUCTS

SERIES 2: CORNER BEAM BRACKET ASSEMBLY GUIDE

Structural Deck Support System: Product Numbers: H1-GQ, H2-GCL, & H2-GCR

STEP 1: Lay framing upon constructed beam and ledger. A cantilevered deck is used to display the function of this bracket. It can be used for similar purposes. In this case, we are using (2) 2x12's for beam and rim joist. Nail overlapped boards typically to hold them in place.

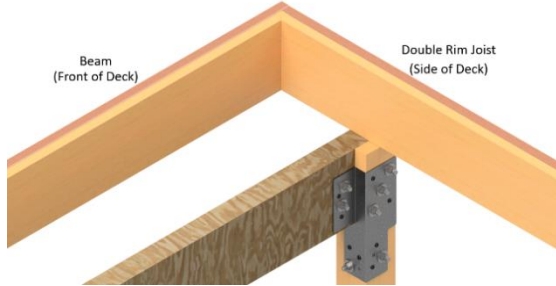

STEP 2: Place the H2-GCB bracket flush against corner, ensuring the bracket is flush along the bottom of the rim joist and beam (Optional: Can use screws or nails to temporarily hold in place).

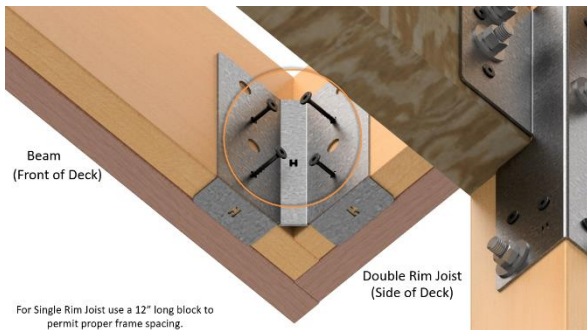

STEP 3: Cut 4x4 handrail posts and toenail or clamp them so that they align with the bolt holes on the bracket side flanges.

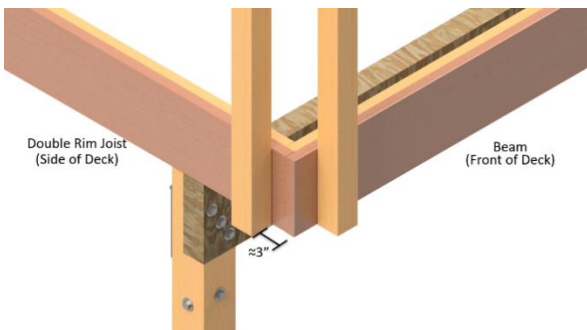

STEP 4: Drill, using each bolt hole in bracket as guides, through all lumber with a minimum 1/2" hole for 1/2" bolts or 5/8" hole for 5/8" bolts.

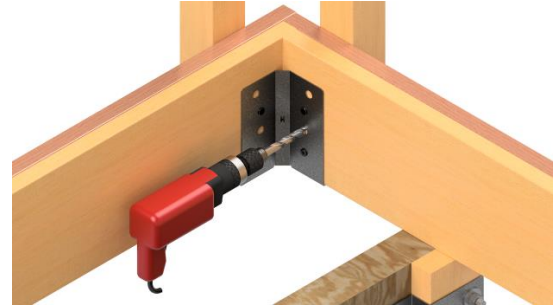

STEP 5: Installing bolts through the outside, fasten them inside the deck with code approved fasteners.

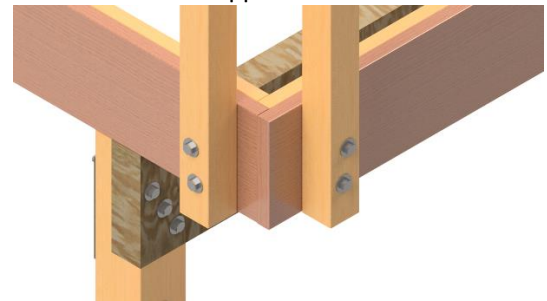

STEP 6: Torque per recommended wood council specs. Bolts are 1/2" diameter minimum. A307 bolts 5/8" thick should be torqued to 73 ft./lbs. A 307 bolts 1/2" thick should be torqued to 37 ft./lbs.

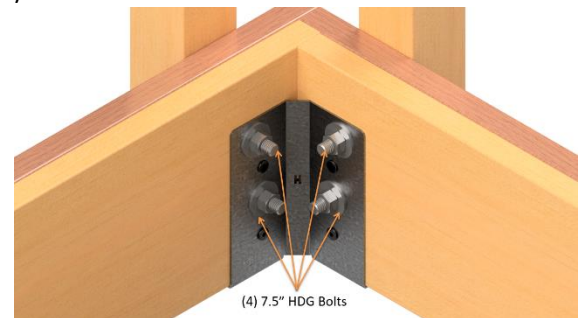

STEP 7: Installation Complete!

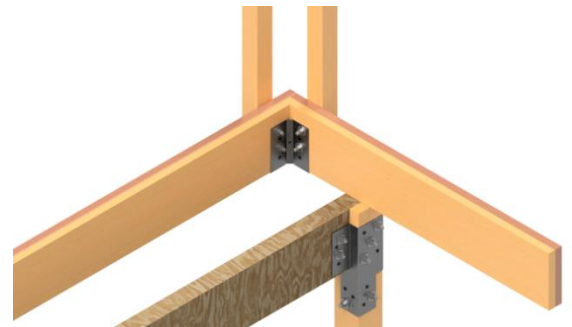

FOR ILLUSTRATED PURPOSES ONLY: SEE ADDITIONAL GUIDELINES PER DECK DESIGN PROFESSIONAL & LOCAL CODE AUTHORITY. INSTALLER IS RESPONSIBLE FOR PREVENTING WATER INTRUSION. TIGHTEN ALL BOLTS & SEAL ALL CAULK. FASTENERS MUST MEET OR EXCEED LOCAL CODE (REC: HDG ASTM 123 HOT DIPPED GALVANIZED OR STAINLESS STEEL) INSTALL ONLY IN PROVIDED, SPECIFIED HOLES. SEE HDGEP.COM FOR SPECS/VIDEOS

SERIES 3: SINGLE STORY DECK POST BRACKET ASSEMBLY GUIDE

Structural Deck Support System: Product Number: H3-GPS

STEP 1: Notch the top of the deck post to accommodate the beam and rim joist used. In this case, we are using (2) 2x12's for beam and rim joist so the notch is approximately 11" long (L) and 3" deep (W) on 2 sides. (For 2x10's cut notch to 9")

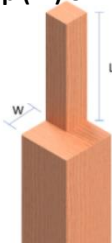

STEP 2: Overlap the rim joist and beam as shown of using 2x lumber. Nail overlapped boards typically to hold them in place.

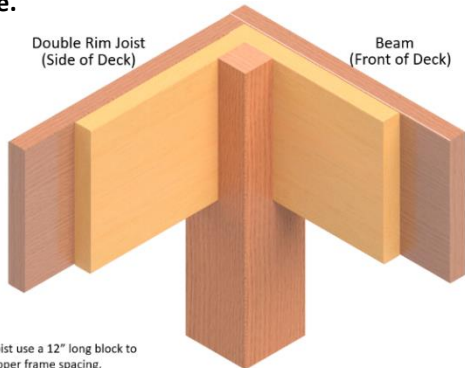

For Single Rim Joist use a 12" long block to permit proper frame spacing.

STEP 3: Place the H3-GPS bracket flush against post, ensuring the bracket is flush along the bottom of the rim joist and beam. (Optional: Can use screws or nails to temporarily hold in place.)

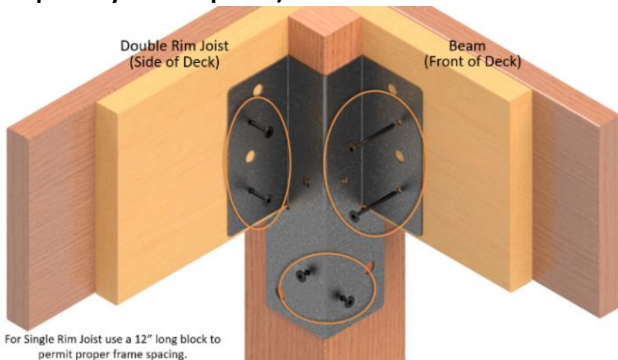

For Single Rim Joist use a 12" long block to permit proper frame spacing.

STEP 4: Cut 4x4 handrail posts and toenail or clamp them so that they align with the bolt holes on the bracket side flanges.

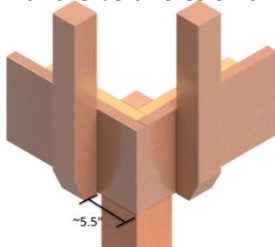

STEP 5: Drill using each bolt hole in bracket as guides, through all lumber with a minimum 1/2" hole for 1/2" bolts.

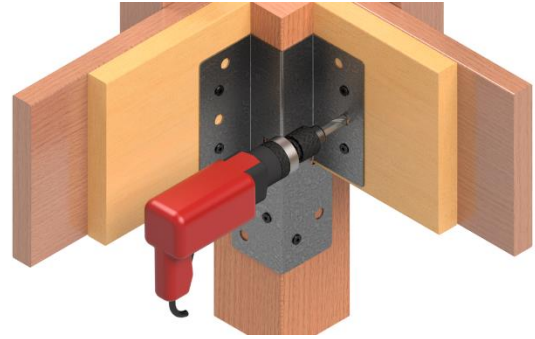

STEP 6: Installing bolts through the outside, fasten them inside the deck with code approved fasteners. Torque per recommended wood council specs. Bolts are 1/2" diameter minimum.

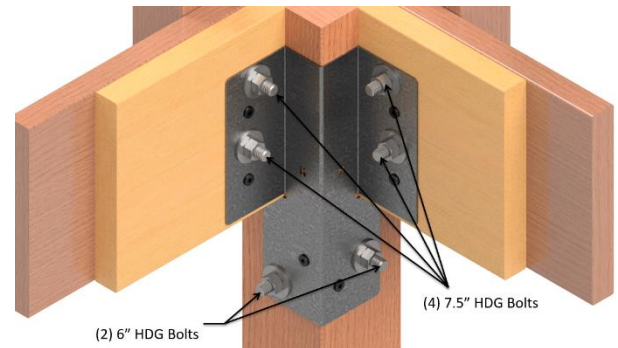

STEP 7: Install 5/4 board decking flush across deck.

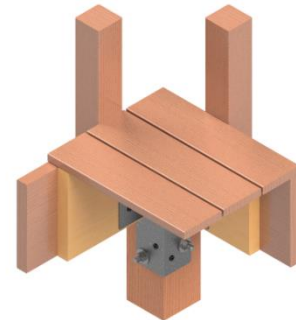

STEP 8: 2x4 knee bracing not required for decks with posts less than 11' high. *Installation Complete!*

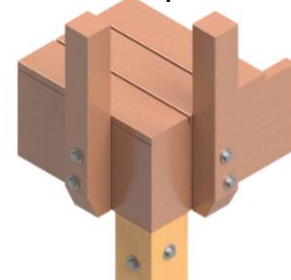

FOR ILLUSTRATED PURPOSES ONLY: SEE ADDITIONAL GUIDELINES PER DECK DESIGN PROFESSIONAL & LOCAL CODE AUTHORITY. INSTALLER IS RESPONSIBLE FOR PREVENTING WATER INTRUSION. TIGHTEN ALL BOLTS & SEAL ALL CAULK. FASTENERS MUST MEET OR EXCEED LOCAL CODE (REC: HDG ASTM 123 HOT DIPPED GALVANIZED OR STAINLESS STEEL) INSTALL ONLY IN PROVIDED, SPECIFIED HOLES. SEE HDGEP.COM FOR SPECS/VIDEOS

STEP 1: Notch the top of the deck post to accommodate the beam and rim joist used. In this case, we are using (2) 2x12's for beam and rim joist so the notch is 5 1/2" long (L) (half the height of the beam) and 3" deep (W) on 2 sides.

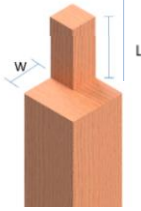

STEP 2: Overlap the rim joist and beam as shown of using 2x lumber. Nail overlapped boards typically to hold them in place.

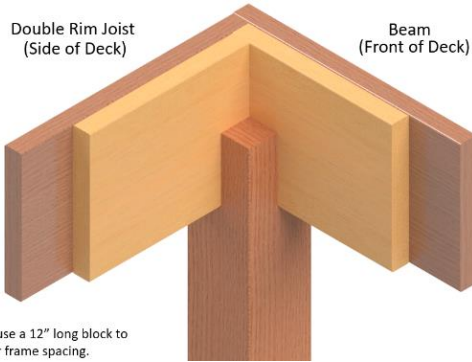

STEP 3: Mount top post in orientation shown, allowing the notched end to fit. Toenail as necessary to temporarily hold post position in place.

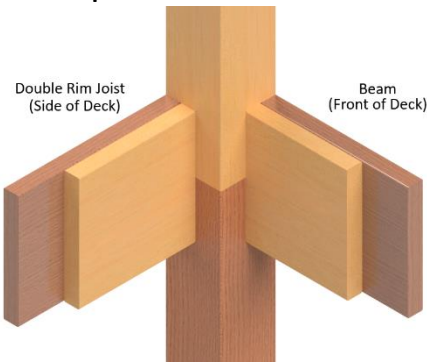

STEP 4: Place the H3-GPM bracket flush against post, insuring the bracket is flush along the bottom of the rim joist and beam (Optional: Can use screws or nails to temporarily hold in place.)

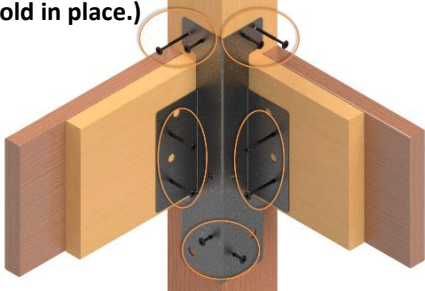

STEP 5: Cut 4x4 handrail posts and toenail or clamp them so that they align with the bolt holes on the bracket side flanges.

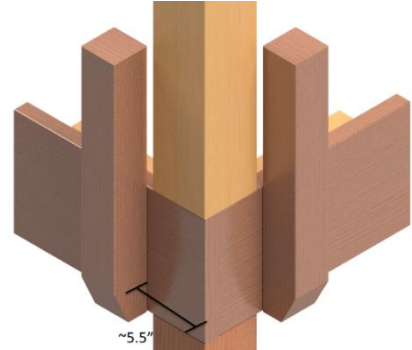

STEP 6: Drill, using each bolt hole in bracket as guides, through all lumber with a minimum 1/2" hole for 1/2" bolts.

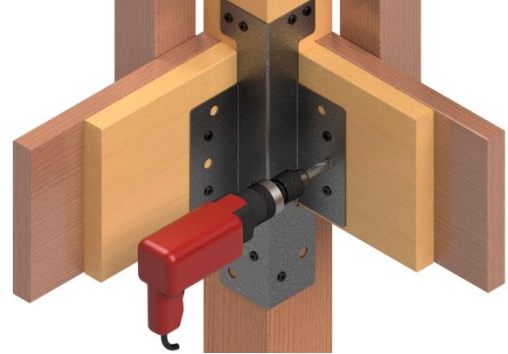

STEP 7: Pushing bolts through from the outside, fasten them inside the deck with provided fasteners. Bolts are 1/2" diameter minimum.

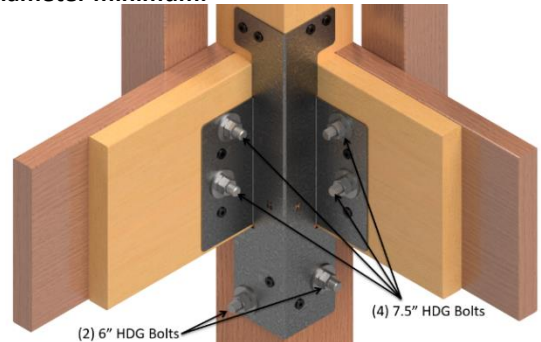

STEP 8: Install 5/4 board decking flush across deck. **Installation Complete!**

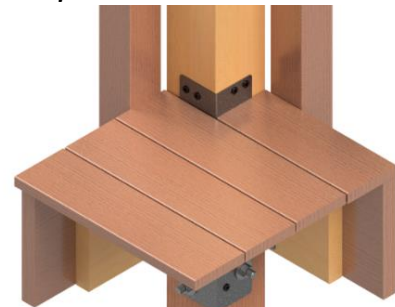

FOR ILLUSTRATED PURPOSES ONLY: SEE ADDITIONAL GUIDELINES PER DECK DESIGN PROFESSIONAL & LOCAL CODE AUTHORITY. INSTALLER IS RESPONSIBLE FOR PREVENTING WATER INTRUSION. TIGHTEN ALL BOLTS & SEAL ALL CAULK. FASTENERS MUST MEET OR EXCEED LOCAL CODE (REC: HDG ASTM 123 HOT DIPPED GALVANIZED OR STAINLESS STEEL) INSTALL ONLY IN PROVIDED, SPECIFIED HOLES. SEE HDGEP.COM FOR SPECS/VIDEOS

SERIES 4: PORCH ROOF TO POST BRACKET ASSEMBLY GUIDE

Structural Deck Support System: Product Number: H4-GPR

STEP 1: Notch 6x6 post to accommodate beam and rim joist widths. For LVL's, width is 2.5". For 2X lumber, width is 4".

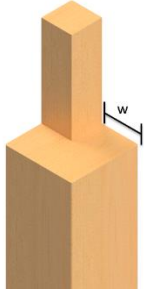

STEP 2: Nail frame typically. For this example, 2X material is used for beam and rim joist.

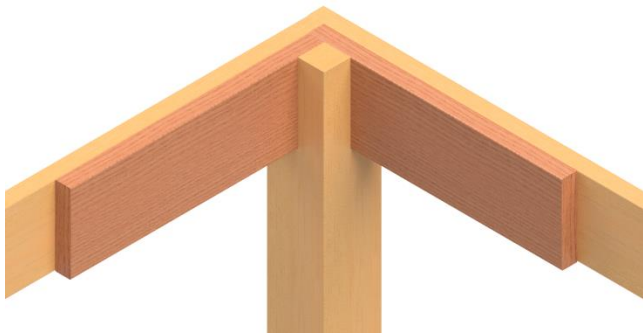

STEP 3: Use 10 screws to fasten the porch roof bracket to frame.



STEP 4: Finished view. Installation Complete!



Cut view to illustrate use with other post brackets.

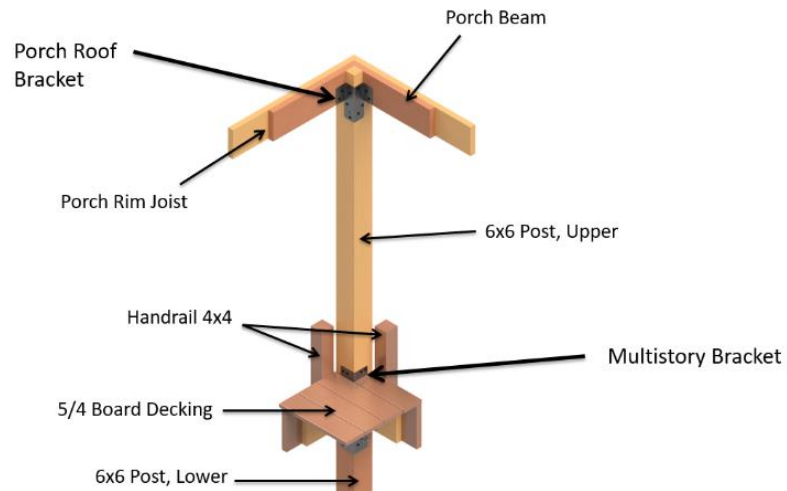

FOR ILLUSTRATED PURPOSES ONLY: SEE ADDITIONAL GUIDELINES PER DECK DESIGN PROFESSIONAL & LOCAL CODE AUTHORITY. INSTALLER IS RESPONSIBLE FOR PREVENTING WATER INTRUSION. TIGHTEN ALL BOLTS & SEAL ALL CAULK. FASTENERS MUST MEET OR EXCEED LOCAL CODE (REC: HDG ASTM 123 HOT DIPPED GALVANIZED OR STAINLESS STEEL) INSTALL ONLY IN PROVIDED, SPECIFIED HOLES. SEE HDGEP.COM FOR SPECS/VIDEOS

SERIES 5: BEAM TO POST BRACKET ASSEMBLY GUIDE

Structural Deck Support System: Product Numbers: H5-GBL3 (Also applies to H5-GBR3)

STEP 1: Notch the one end of each deck post to accommodate the beam used. In this case, we are using a 3 1/2" x 12" LVL or PSL beam so the notch is 11.25" long (L) and 3" deep (W).

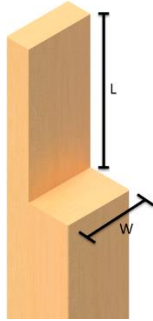

STEP 2: Set the beam across the posts as shown. Fasten overlapped boards temporarily to hold them in place.

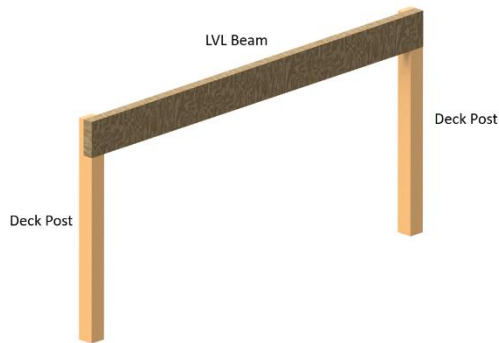

STEP 3: Place the H5-GBL3 bracket flush against post, ensuring the bracket is flush along the bottom of the beam (Optional: Can use screws or nails to temporarily hold in place).

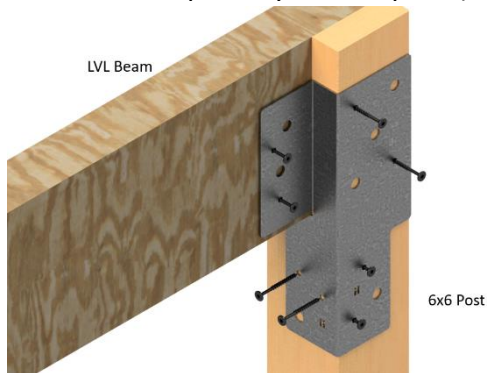

STEP 4: Drill, using each bolt hole in bracket as guides, through all lumber with a minimum 1/2" hole for 1/2" bolts or 5/8" hole for 5/8" bolts.

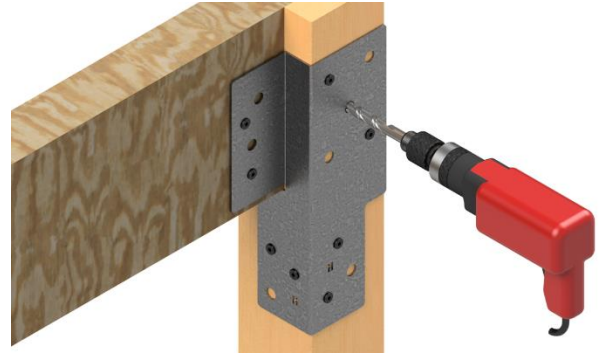

STEP 5: Pushing bolts through the outside, fasten them inside the deck with provided fasteners. Torque per recommended wood council specs. Bolts are 1/2" diameter minimum. *Installation Complete!*

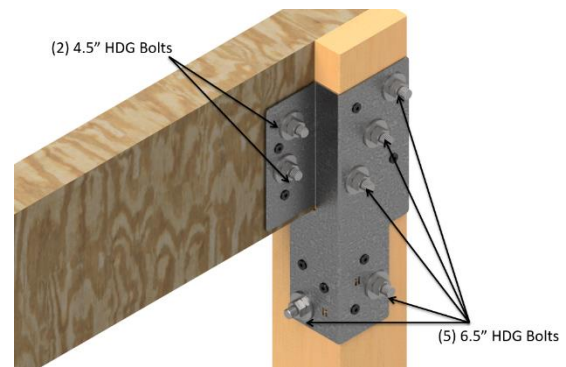

FOR ILLUSTRATED PURPOSES ONLY: SEE ADDITIONAL GUIDELINES PER DECK DESIGN PROFESSIONAL & LOCAL CODE AUTHORITY. INSTALLER IS RESPONSIBLE FOR PREVENTING WATER INTRUSION. TIGHTEN ALL BOLTS & SEAL ALL CAULK. FASTENERS MUST MEET OR EXCEED LOCAL CODE (REC: HDG ASTM 123 HOT DIPPED GALVANIZED OR STAINLESS STEEL) INSTALL ONLY IN PROVIDED, SPECIFIED HOLES. SEE HDGEP.COM FOR SPECS/VIDEOS

HDG ENGINEERED PRODUCTS

SERIES 5: KNEE BRACE BRACKET ASSEMBLY GUIDE

Structural Deck Support System: Product Number: H5-GNL (Also applies to H5-GNR)

STEP 1: Cut 4x4 or knee brace to length with 45-degree angle on end, as appropriate

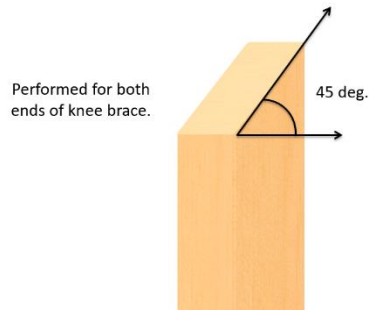

STEP 2: Place the knee brace into position on the frame. Toenail to hold its position for bracket installation.

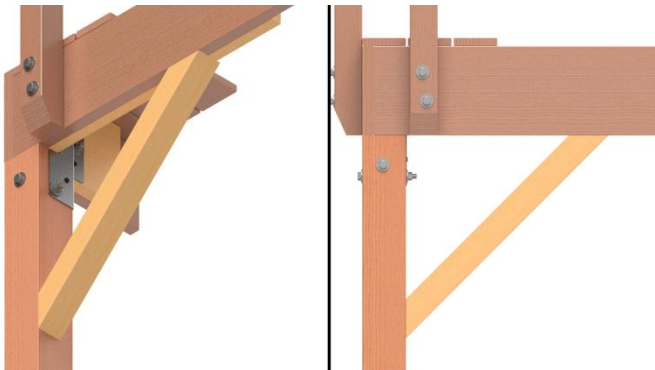

STEP 3: Use 10 screws per bracket to fasten the knee brace to frame.



STEP 4: Use 10 screws per bracket to fasten the knee brace to frame.

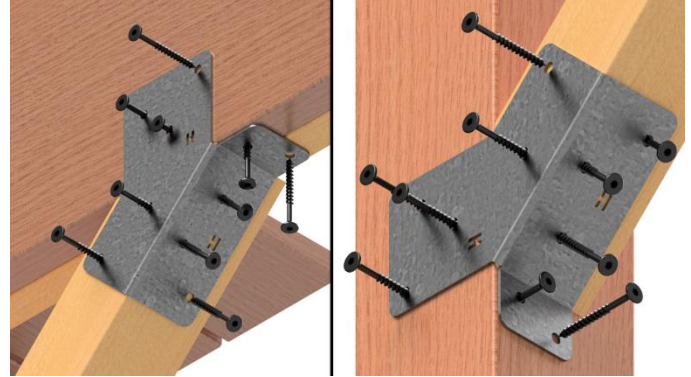

STEP 5: Installation Complete!



FOR ILLUSTRATED PURPOSES ONLY: SEE ADDITIONAL GUIDELINES PER DECK DESIGN PROFESSIONAL & LOCAL CODE AUTHORITY. INSTALLER IS RESPONSIBLE FOR PREVENTING WATER INTRUSION. TIGHTEN ALL BOLTS & SEAL ALL CAULK. FASTENERS MUST MEET OR EXCEED LOCAL CODE (REC: HDG ASTM 123 HOT DIPPED GALVANIZED OR STAINLESS STEEL) INSTALL ONLY IN PROVIDED, SPECIFIED HOLES. SEE HDGEP.COM FOR SPECS/VIDEOS

HDG ENGINEERED PRODUCTS

SERIES 6: POST BASE ASSEMBLY GUIDE

Structural Deck Support System: Product Number: H6-GB6

STEP 1: Attach post base bracket to 6x6 post using recommended screws.

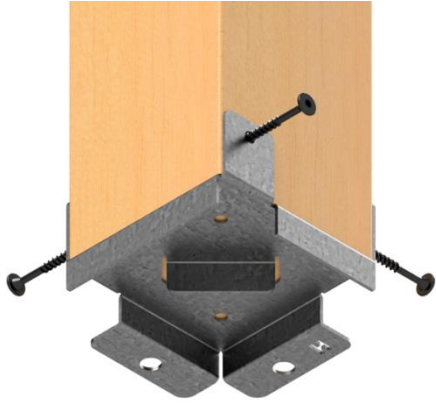

STEP 2: Position post centered over footing. Make sure bottom of bracket is flush with grade to allow 1" off grade code requirement.



STEP 3: Place Anchor Bolts.

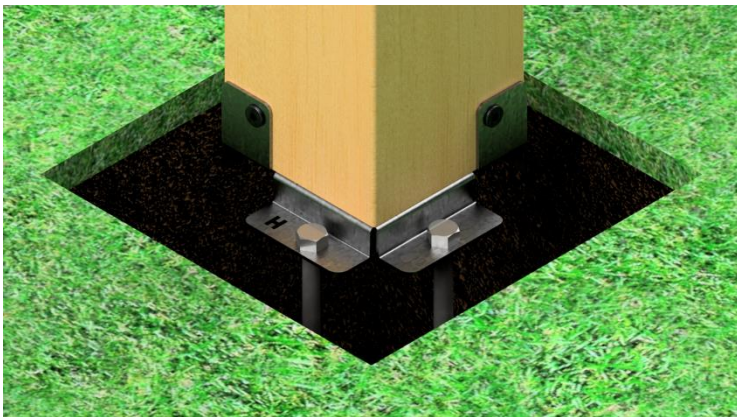

STEP 4: Fill footing with concrete. *Installation Complete!*

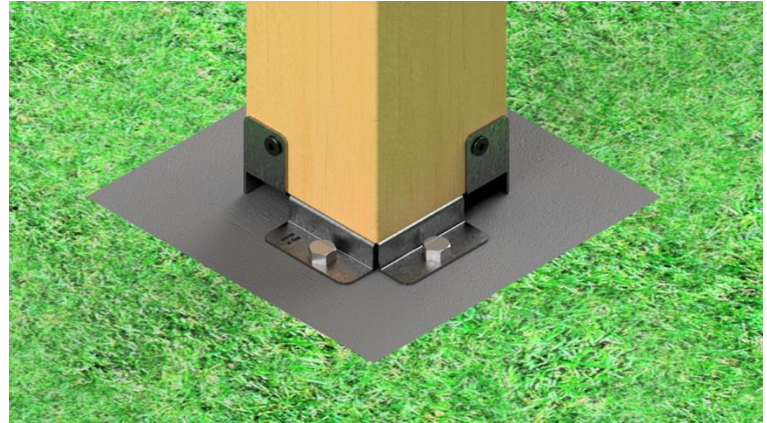

Cut view to illustrate use with other post brackets.

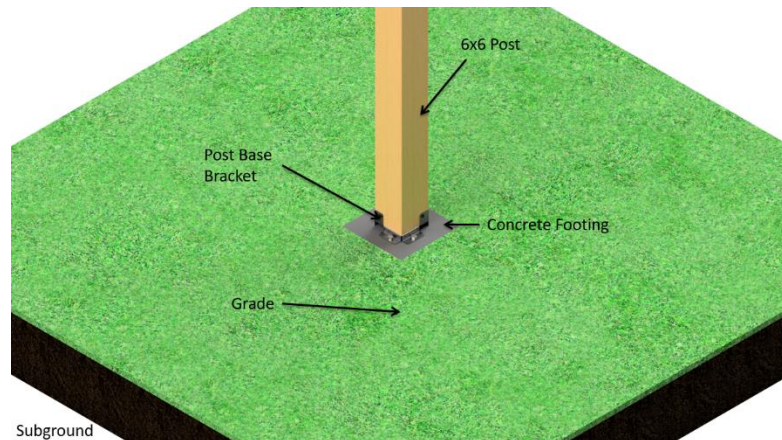

FOR ILLUSTRATED PURPOSES ONLY: SEE ADDITIONAL GUIDELINES PER DECK DESIGN PROFESSIONAL & LOCAL CODE AUTHORITY. INSTALLER IS RESPONSIBLE FOR PREVENTING WATER INTRUSION. TIGHTEN ALL BOLTS & SEAL ALL CAULK. FASTENERS MUST MEET OR EXCEED LOCAL CODE (REC: HDG ASTM 123 HOT DIPPED GALVANIZED OR STAINLESS STEEL) INSTALL ONLY IN PROVIDED, SPECIFIED HOLES. SEE HDGEP.COM FOR SPECS/VIDEOS

HDG ENGINEERED PRODUCTS

SERIES 7: REINFORCEMENT BRACKET ASSEMBLY GUIDE

Structural Deck Support System: Product Number: H7-GJR

STEP 1: Identify the H1 series bracket or ledger bolt you want to reinforce.



STEP 2: Position the joist retaining strap utilizing the available spaces. Use the ledger bolt to fasten one into the inside of the rim joist.

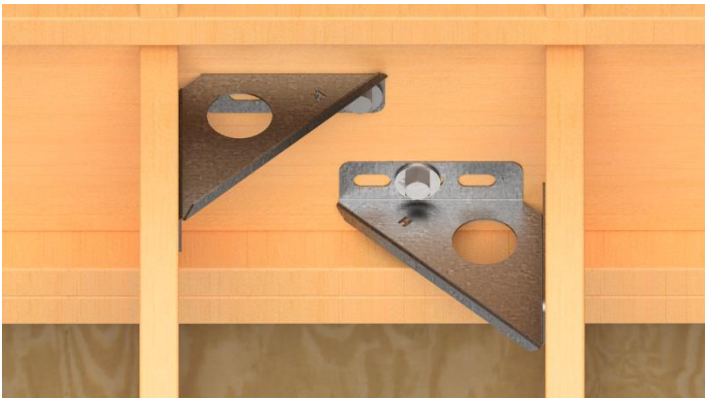

STEP 3: Drill 2 holes for bolts.

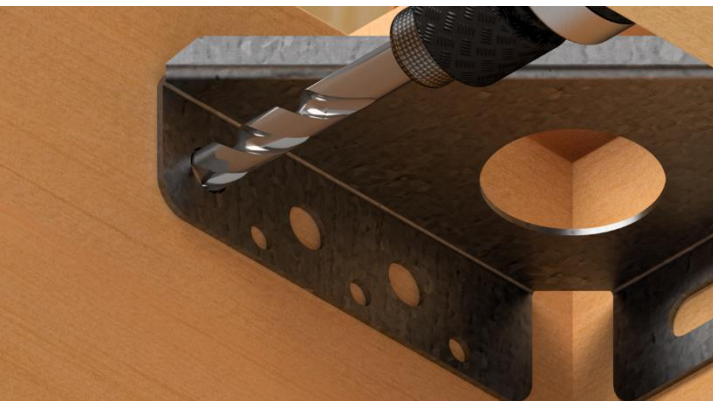

STEP 4: Fasten 2 bolts per bracket. Use 3" long 1/2" thread HDG steel bolts.

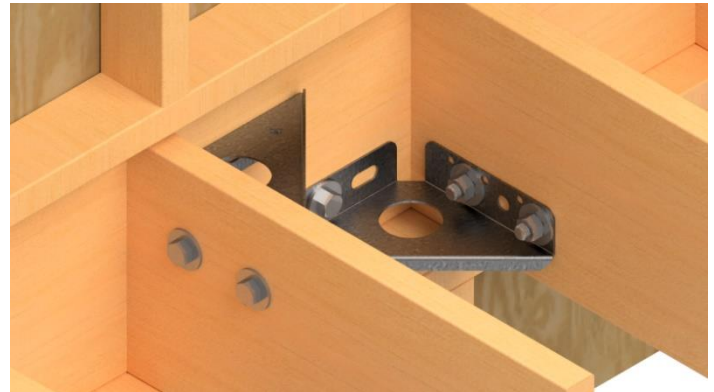

STEP 5: Bottom view to illustrate use with other post brackets. *Installation Complete!*

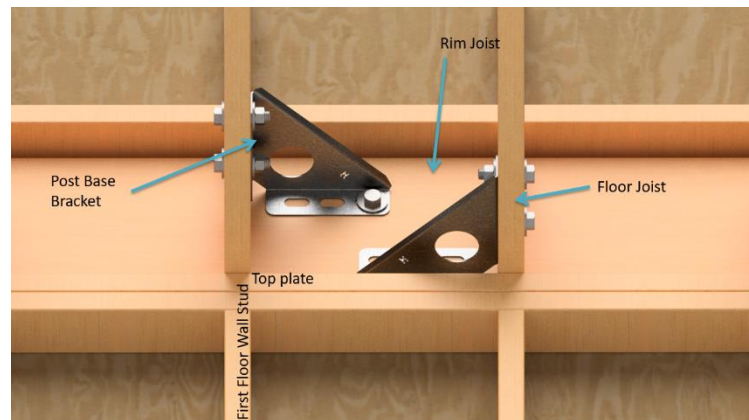

Top view to illustrate use with other post brackets.

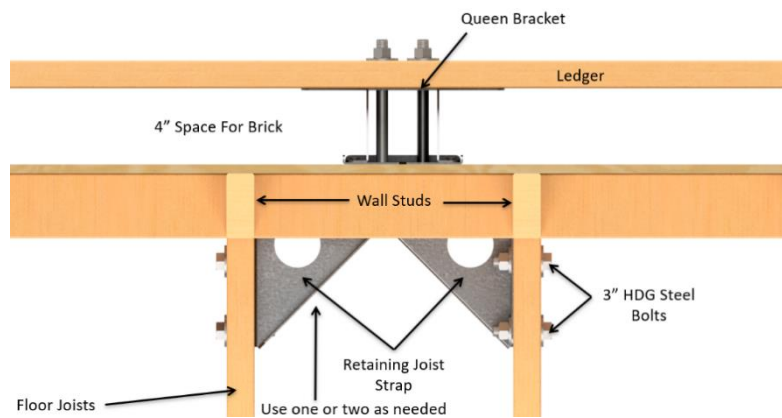

FOR ILLUSTRATED PURPOSES ONLY: SEE ADDITIONAL GUIDELINES PER DECK DESIGN PROFESSIONAL & LOCAL CODE AUTHORITY. INSTALLER IS RESPONSIBLE FOR PREVENTING WATER INTRUSION. TIGHTEN ALL BOLTS & SEAL ALL CAULK. FASTENERS MUST MEET OR EXCEED LOCAL CODE (REC: HDG ASTM 123 HOT DIPPED GALVANIZED OR STAINLESS STEEL) INSTALL ONLY IN PROVIDED, SPECIFIED HOLES. SEE HDGEP.COM FOR SPECS/VIDEOS